

STEREO POWER AMPLIFIER

# KAC-622

## INSTRUCTION MANUAL

B64-0027-00

# KENWOOD

KENWOOD CORPORATION

# FILE

PRINTED IN JAPAN REV. 2027-00(KIT)  
2012.11.10.9

**Take the time to read through this instruction manual. Familiarity with installation and operation procedures will help you obtain the best performance from your new power amplifier.**

### For your records

Record the serial number found on the back of the unit, in the spaces designated on the warranty card, and in the space provided below. Refer to the model and serial numbers whenever you call upon your KENWOOD dealer for information or service on this product.

Model KAC-622 Serial number \_\_\_\_\_

## ACCESSORY

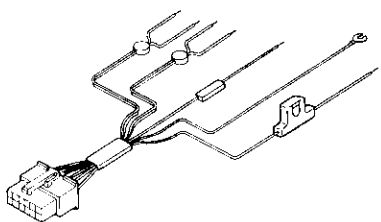
No.	Part name	External View	Number of units
①	Power connection cord	 E30-3884-05	1

# WARNING

TO PREVENT ELECTRIC SHOCK,  
FIRE AND OTHER INJURY,  
PLEASE NOTE THE FOLLOWINGS:

To keep good ventilation, do not put anything on top of the unit.

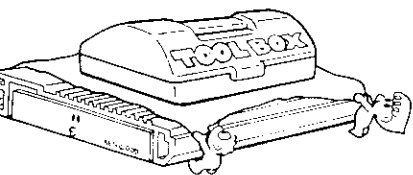

The unit is designed to be connected 12 V DC and negative grounding.

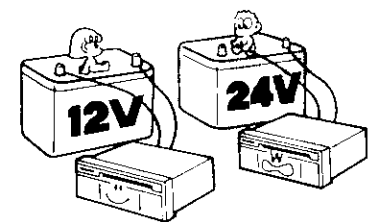

Do not open enclosure, such as front panel, top or bottom cover.

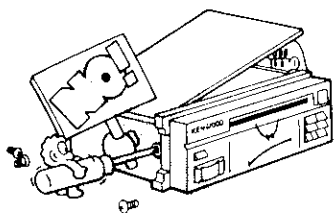

- Do not drop pieces of metal, needles, coins and other electrically conductive materials into the unit.

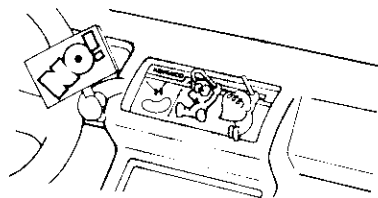

- Do not place the unit, where it will be exposed to direct sunlight or close to heating device.

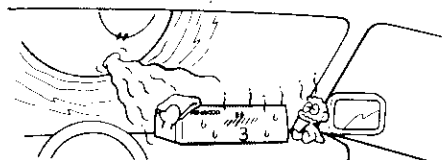

- Do not dash water on the unit.

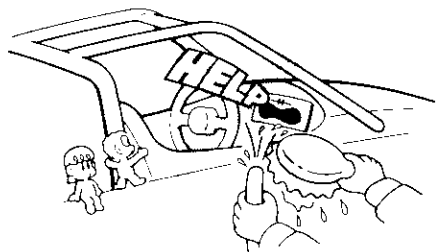

- Do not place the unit in areas of excessive dust, high humidity or on unstable surfaces.

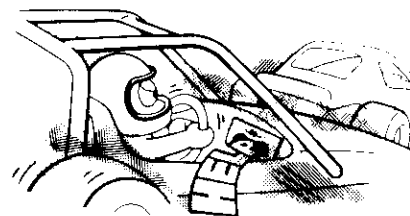

- If an abnormal smell or smoke is detected, immediately turn the power off.

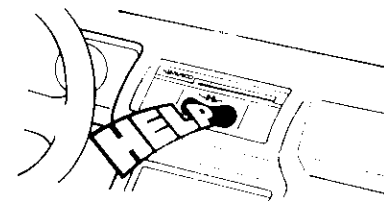

- If you have difficulty in installing the set in your car, please contact your KENWOOD dealer.

## CLEANING

1. Turn the power off, before cleaning the unit.
2. Do not use any type of abrasive pad, thinner, benzine and any such kind of objects.
3. Wipe the front panel and other exterior surfaces of the unit with a soft dry cloth or a soft cloth lightly moistened with a neutral detergent.

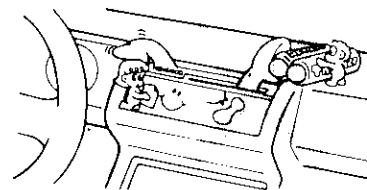

## FCC WARNING:

This equipment may generate or use radio frequency energy. Changes or modifications to this equipment may cause harmful interference unless the modifications are expressly approved in the instruction manual. The user could lose the authority to operate this equipment if an unauthorized change or modification is made.

# USE OF THE OPERATION PANEL ACCORDING TO SYSTEM TYPE

# CONSTANT TABLE OF NETWORK FOR 3D

You can construct a multiple speaker system through the use of passive crossovers (coil and capacitors) as shown below: (if the coils and capacitors are not available in the value listed, coils and capacitors with similar or close values can be used without affecting the performance in practical use.)

## ■ 6 dB/Octave for High and Low pass Filter

### ■ Function of a High Pass filter

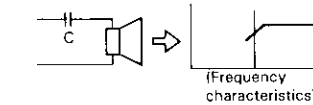

### ■ Function of a Low Pass filter

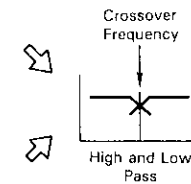
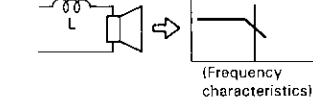

### ■ 6 dB/Octave w/Sub Woofer and Full Range Speakers

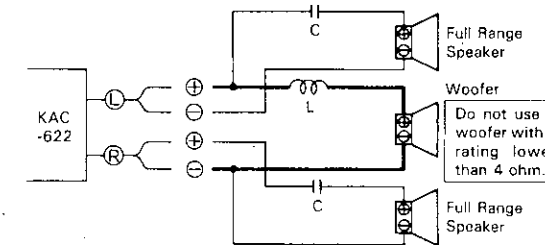

Table of content for 6 dB (4 Ohm)

Cross-over Frequency	L (Coil)	C (Capacitor)
30Hz	21.2mH	1330 $\mu$ F
50Hz	12.7mH	800 $\mu$ F
80Hz	8.0mH	500 $\mu$ F
100Hz	6.4mH	400 $\mu$ F
150Hz	4.2mH	270 $\mu$ F
200Hz	3.2mH	200 $\mu$ F
260Hz	2.4mH	150 $\mu$ F
400Hz	1.6mH	100 $\mu$ F
600Hz	1.1mH	70 $\mu$ F
800Hz	0.8mH	50 $\mu$ F

When using a 2 ohm speaker, use half the value of the coil for low pass and use twice the value of the capacitor for high pass.  
 Example: 30 Hz L = 10.6 mH, C = 2660  $\mu$ F  
 When using a 8 ohm speaker, use twice the value of the coil for low pass and use half the value of the capacitor for high pass.  
 Example: 30 Hz L = 42.4 mH, C = 665  $\mu$ F

## ■ 12 dB/Octave for High and Low pass Filter

### ■ Function of a High Pass filter

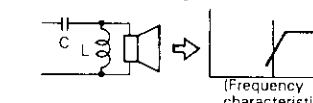

### ■ Function of a Low Pass filter

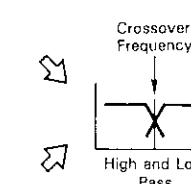
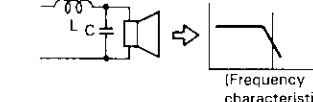

### ■ 12 dB/Octave w/Sub Woofer and Full Range Speakers

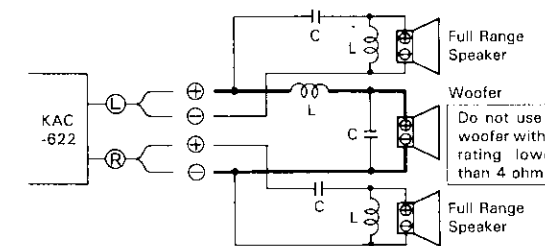

Table of content for 12 dB (4 Ohm)

Cross-over Frequency	L (Coil)	C (Capacitor)
30Hz	29.7mH	950 $\mu$ F
50Hz	17.8mH	570 $\mu$ F
80Hz	11.1mH	350 $\mu$ F
100Hz	8.9mH	280 $\mu$ F
150Hz	5.9mH	190 $\mu$ F
200Hz	4.5mH	140 $\mu$ F
260Hz	3.4mH	110 $\mu$ F
400Hz	2.2mH	70 $\mu$ F
600Hz	1.5mH	48 $\mu$ F
800Hz	1.1mH	35 $\mu$ F

When using a 2 ohm speaker, use half the value of the coil for low pass and use twice the value of the capacitor for high pass.  
 Example: 30 Hz L = 14.9 mH, C = 1900  $\mu$ F  
 When using a 8 ohm speaker, use twice the value of the coil for low pass and use half the value of the capacitor for high pass.  
 Example: 30 Hz L = 59.4 mH, C = 475  $\mu$ F

### • Input sensitivity control

The input sensitivity control adjusts the input sensitivity within a range of 0.1 V to 5.0 V continuously, enabling expansion with various systems. This unit has been set for 0.3 V.

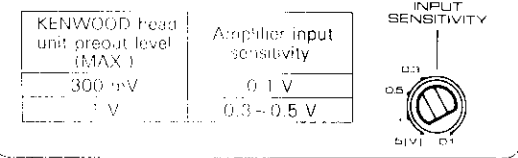

### • Mode switch

This switch is used to set the unit's output system to Stereo (Normal) or Mono. (Bridged) as described below.

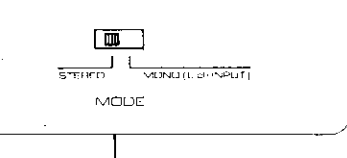

■ This unit is provided with a bridged output function which enables you to double the unit's power output. Since the output becomes monaural when the bridged output function is used, systems can be configured such as those shown below. (for 4  $\Omega$  speakers)

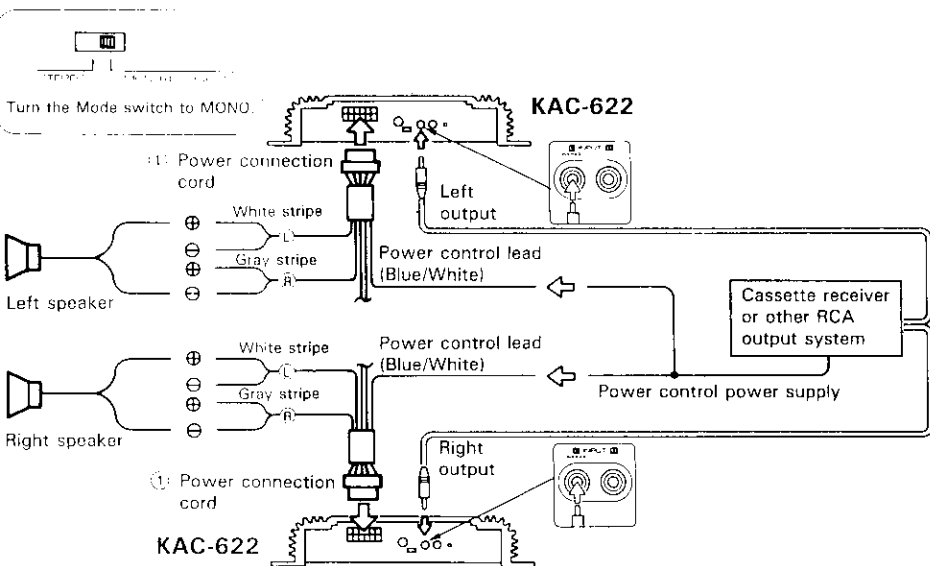

## INSTALLATION

1. Before installation and wiring, remove the  $\ominus$  terminal of the battery to prevent short-circuiting.
2. Connect the input and output cords of the system.
3. Connect the ground to the metal chassis of the car.
4. Connect the power supply lead (yellow).
5. Install the set and after confirming the installation and wirings are correct, connect the  $\oplus$  terminal of the battery.



- If a fuse is blown, first check that the associated wires are not short-circuited then replace the fuse with a new one having the same capacity.

### CAUTION

Always connect the without white stripe, gray stripe speaker wires to the  $\ominus$  terminals of the speaker systems. Never let the  $\ominus$  speaker wires touch and never connect them to the chassis (ground). Do not let the speaker terminals come into contact with the chassis (ground). Insulate any unused output wire with vinyl tape to prevent a short circuit.

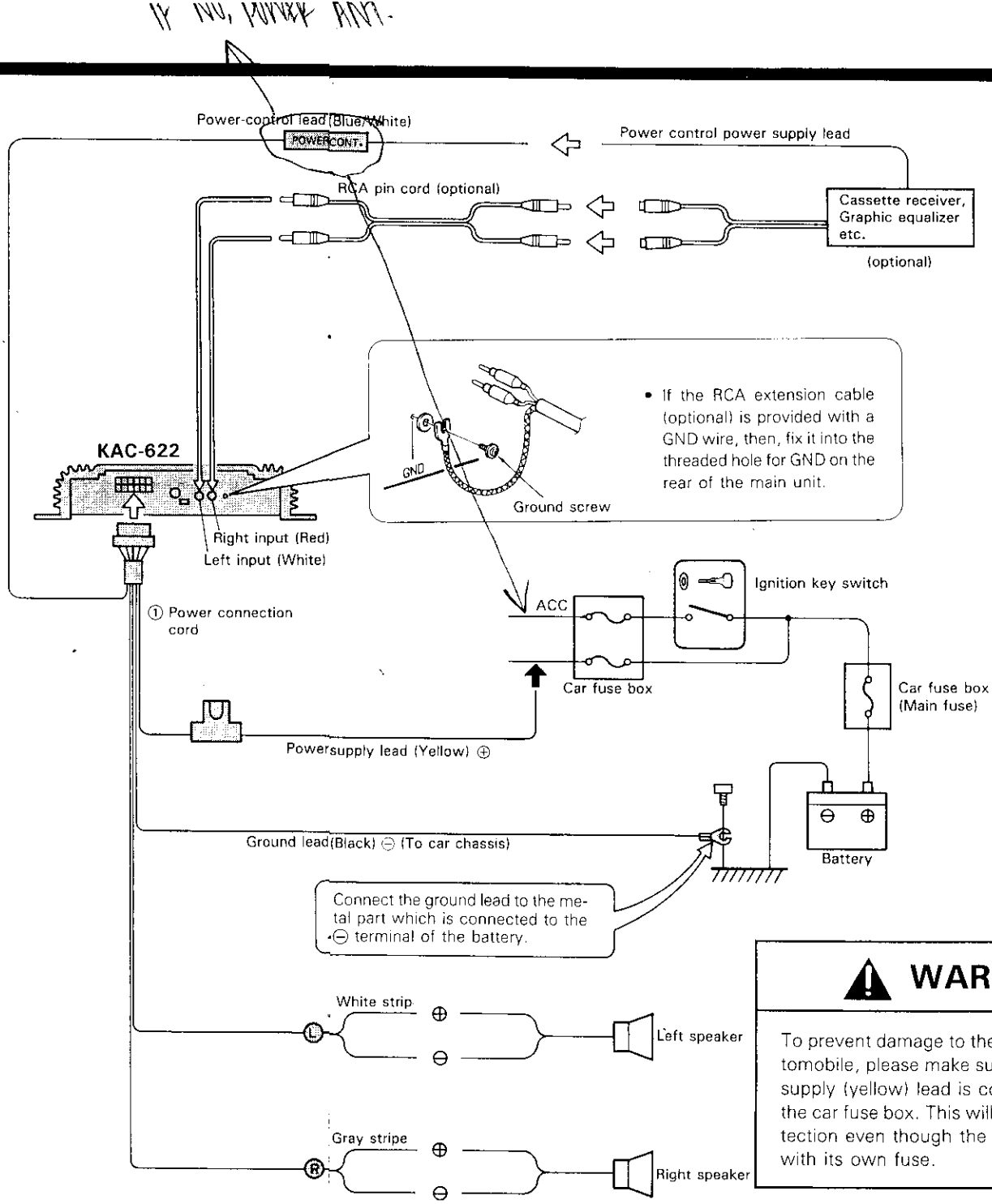

### WARNING

To prevent damage to the radio or your automobile, please make sure that the power supply (yellow) lead is connected through the car fuse box. This will be an added protection even though the radio is equipped with its own fuse.

# INSTALLATION

## 1. Installation

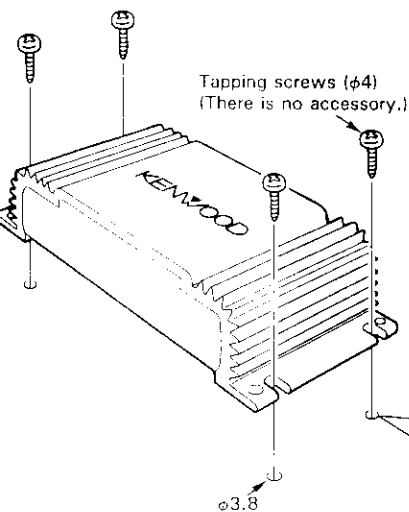

- When installing to the car, install the unit securely for safety driving.
- Install the unit in a well-ventilated place and do not place the (heavy) object on it.

### CAUTION

When making the hole, do not damage the fuel tank, brake tube, wiring harnesses, etc. on the other side.

## 2. Installation location

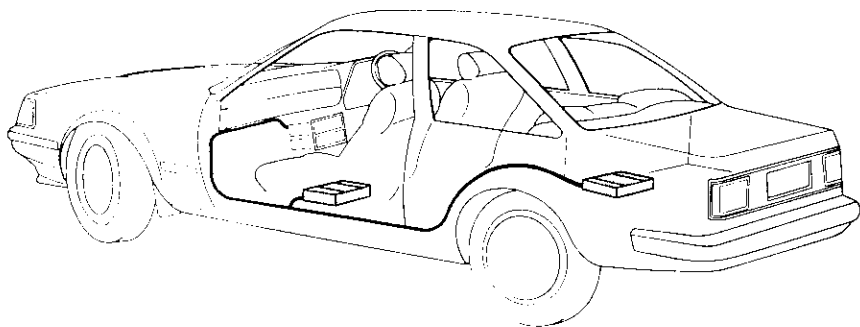

- Since the power amplifier has no parts which require operation, it can be installed at a position away from the driver's seat without any hinderances. As generally accepted positions for its installation, places such as under the front seat or inside the trunk, etc. can be considered.
- Use the extension cables. CA-5W/3W (0.5 m), CA-15W/13W (1 m), CA-25W/23W (2 m), CA-45W/43W (4 m) and CA-65W/63W (6 m) (optional) when the connected models are to be installed away from the power amplifier.

# TROUBLESHOOTING GUIDE

What often appears to be a malfunction is often due to user error in operation or connection. When trouble occurs with your unit, please check the following before calling for service.

Symptom	Cause	Remedy
<b>The sound level is low. (No sound from one side.)</b>	A speaker cord has become unconnected.	Check the speaker cord connections.
<b>The sound quality is bad. (The sound is distorted.)</b>	1. The speakers are connected to the same wires. 2. A speaker cord is pinched by a screw in the car body.	1. Connect each speaker terminal to its respective speaker output. 2. Check the speaker wiring.

## SPECIFICATIONS

Specifications subject to change without notice.

### Audio section

Max Power Output	
Normal (STEREO).....	60 W + 60 W
Bridged (MONO).....	130 W
Power Output	
Normal (STEREO) (20 Hz ~ 20 kHz, 4 Ω, less than 0.08% THD).....	30 W + 30 W
Bridged (MONO) (1 kHz, 4 Ω, 0.8% THD).....	80 W
Output Power	
Normal (STEREO) (1 kHz, 2 Ω, 0.8% THD).....	40 W + 40 W
Frequency Response (-3 dB).....	4 Hz ~ 65 kHz
Signal to Noise Ratio.....	100 dB
Sensitivity (rated output) MAX.....	0.1 V
MIN.....	5.0 V
Input Impedance.....	10 kΩ
Damping Factor (100 Hz).....	More than 100

### General

Operating Voltage.....	14.4 V (11 ~ 16 V allowable)
Current Consumption (MAX.).....	15 A
Dimensions (W × H × D).....	203 × 48 × 140 mm (8 × 1-7/8 × 5-1/2 in.)
Weight.....	1.6 kg (3.5 lb)